

# FRITSCH

HANDCRAFTED DRAPERY HARDWARE



# FRITSCH

The Fritsch collection of transitional iron and sleek artisan steel drapery hardware is handcrafted in Germany. Fritsch incorporates innovation with an unrivaled level of craftsmanship and offers a vast range of beautiful finishes and thoughtful details that are fully customizable allowing for a variety of versatile applications.



**FRITSCH**

IRON FINISH / TAURUS CARRIER AND FINIAL

# CONTENTS

**Finish Overview** 1

**Customization** 2

## **Hand-Forged Iron**

Carriers 4

Finials 5-6

Folding Rods 7

Accessories 8

## **Smooth Iron**

Carriers 10

Finials 11-12

## **Stainless Steel**

Carriers 14-16

Finials 17-18

Accessories 20

Hand-Forged Iron Collection 21

Smooth Iron Collection 22

Stainless Steel Collection 23

Aluminum Collection 24

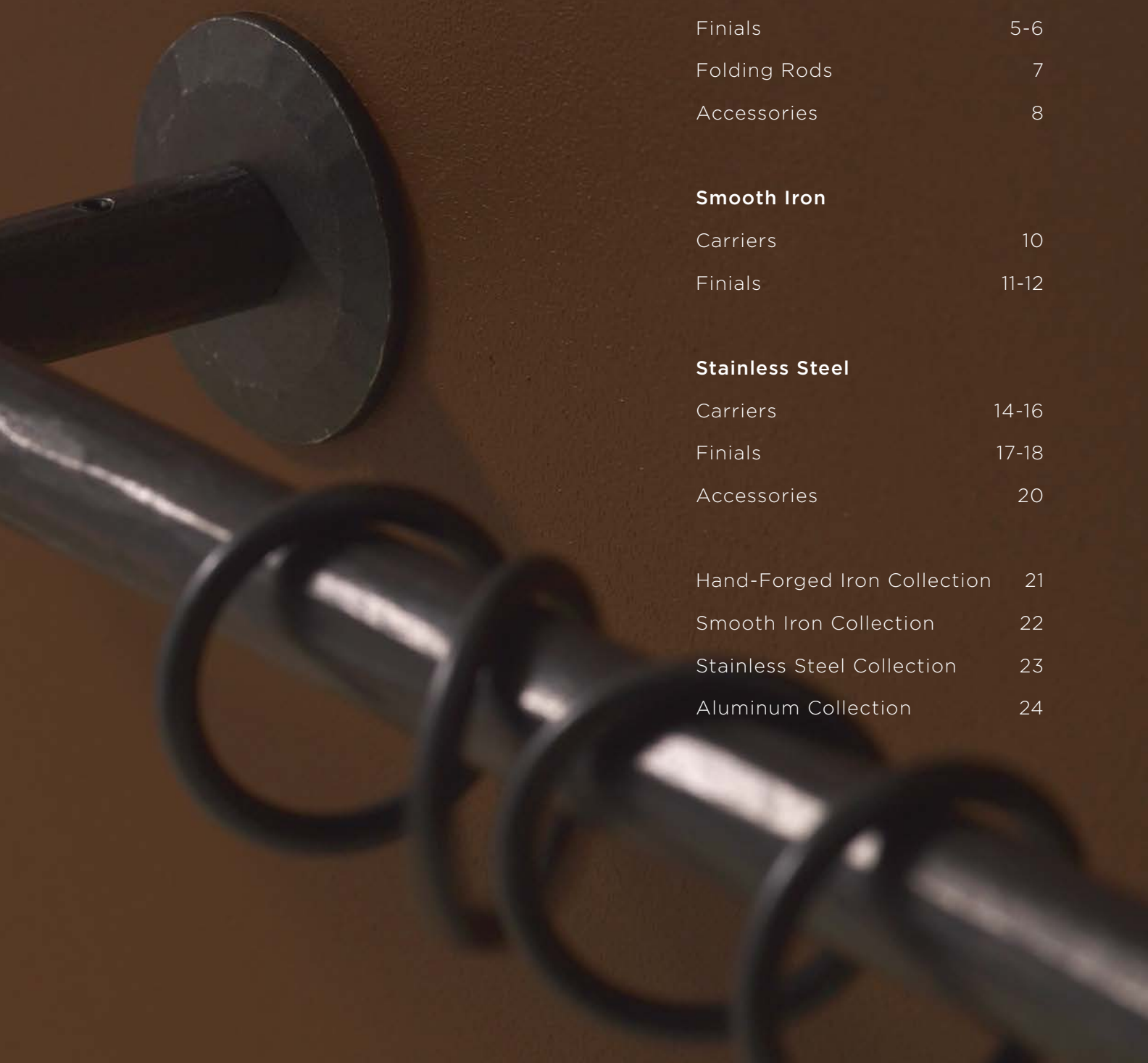



## SMOOTH IRON / FORGED IRON

Smooth Iron is hand machined from solid steel with a waxed surface.

Forged Iron is hand-forged from solid steel using Old World forging techniques. All rods are individually forged by hand, giving each a character and quality unique to the hands of the respective blacksmith.

Forged Iron and Smooth Iron drapery hardware are standard with a brushed and waxed iron surface. Both are also available in the following artisanal hand-applied finish options: **Bronze, Copper, Gold, Olive Bronze, Silver, Edelrost, and Schwarz Gilt Patinas.** Brass and nickel finials available in polished or matte finishes.

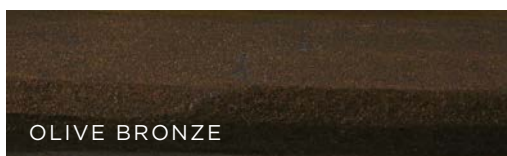
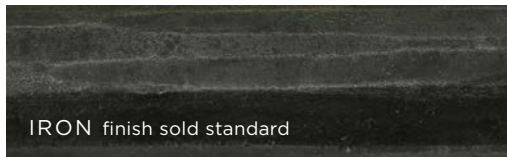

## STAINLESS STEEL

Stainless Steel is constructed of machined stainless steel and is standard with a brushed finish. Also available in the following finish options: **Polished, Anthracite, Coffee Brown, Satin, Sienna Brown, Pinot, Absinth, Chablis** or custom colors finished to match any Pantone color.

Email [scott@fritschdraperyhardware.com](mailto:scott@fritschdraperyhardware.com) or call 626.298.3500 for details and pricing.

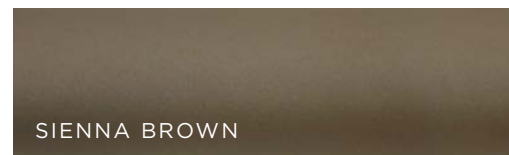
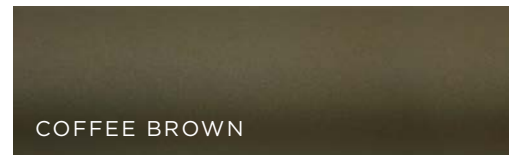
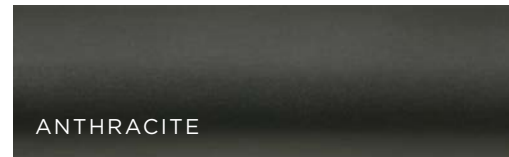



## CUSTOMIZATION

Fritsch's handcraftsmanship allows for the customization of any piece with few exceptions. Specialized curved bay window rods, any variety of custom back plates and rod diameters, even custom painted stainless steel in any Pantone® color—the possibilities are nearly limitless. A quote and a scale drawing for your approval will be provided for custom requests.



HAND-FORGED IRON

FRITSCH

IRON FINISH / PIN CARRIER



# CARRIERS



CUT



PIN



MANO



STAKKATO



MANO PASS-THROUGH



TAURUS

All carriers available as standard in  $\frac{5}{8}$ " diameter and standard wall distances of  $2 \frac{3}{4}$ " or  $3 \frac{7}{8}$ ".  
Forged iron carriers available for single or double rods.

FRITSCH

# FINIALS



CUT



PASO



PIN



PIN (with ball)

\*Available with brass (*shown*), iron or nickel ball end.



STAKKATO



STAKKATO (with ball)

\*Available with brass (*shown*), iron or nickel ball end.



TAURUS



TAURUS (with ball)

\*Available with brass (*shown*), iron or nickel ball end.



SNAKE

Available in  $\frac{5}{8}$ " or  $\frac{1}{2}$ " diameter.

\*Brass or nickel available in polished or matte finish.

FRITSCH



VOLUTE (large)



CURL



VOLUTE (small)



SWAN



LOOP



SCHILF



WIND

Available in  $\frac{5}{8}$ " or  $\frac{1}{2}$ " diameter.

**FRITSCH**

# FOLDING RODS



TAURUS



PIN

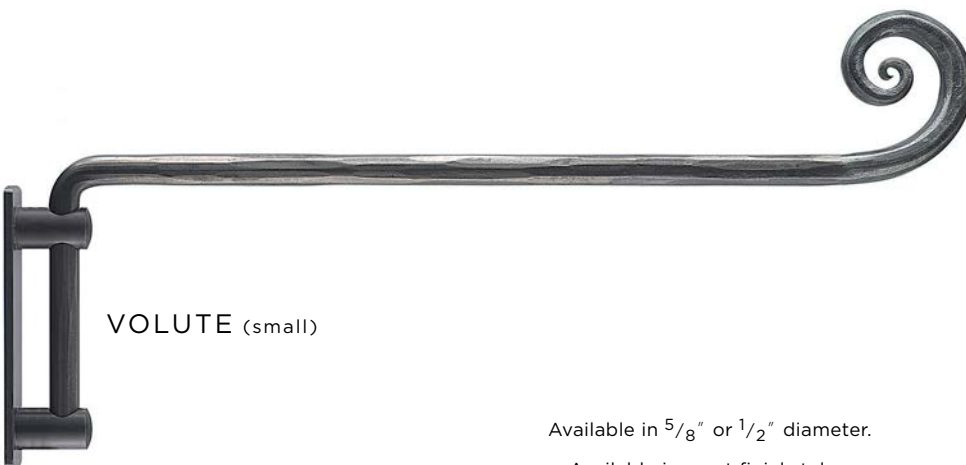

VOLUTE (small)

Available in  $\frac{5}{8}$ " or  $\frac{1}{2}$ " diameter.

Available in most finial styles.

**FRITSCH**



# ACCESSORIES



**PIN RAFFARM**  
1/2" diameter



**FLAT  
BACK PLATE**  
1 13/16" diameter



**FORGED  
BACK PLATE**  
1 13/16" diameter



**TAURUS HOOK**  
5/8" diameter



**PIN TIE-BACK**  
5/8" diameter



**ARCHED  
BACK PLATE**  
2 3/8" diameter



**IRON RINGS**  
1 5/16", 1 9/16"  
or 1 3/4" diameter



**BRASS RING**  
1 5/8" or 2 1/2" diameter  
Available in four\* finishes.  
*\*(See showroom for details.)*



**PASS-THROUGH RINGS**  
Available for Mano and  
Center Support Carriers  
in 1 3/4" diameter.

Anthracite Iron (*shown above*)  
Polished Brass  
Matte Brass  
Matte Nickel

Also available with nylon inserts.

Additional accessories available.

**FRITSCH**



SMOOTH IRON

FRITSCH

IRON FINISH / BRASS AND IRON SPUTNIK FINIAL

# CARRIERS



CUP



SPUTNIK



ZYLON



KUGEL

All carriers available in  $\frac{5}{8}$ " diameter and standard wall distances of  $2\frac{3}{4}$ " and  $3\frac{7}{8}$ ".  
These carriers available in iron, brass or nickel. Brass and nickel finials available with polished or matte finish.

Smooth iron carriers available for single or double rods.

**FRITSCH**

# FINIALS



CUP



SPUTNIK



ZYLON



ITON



KUGEL

Ball available in 1 1/4" or 1 1/2".

Available in 5/8" diameter.

These finials available in iron, brass or nickel. Brass and nickel finials available with polished or matte finish.

**FRITSCH**





ZETA



POINT



TUBE



SAX

Available in  $\frac{5}{8}$ " diameter.

These finials available in brass or nickel with polished or matte finish.

**FRITSCH**

A close-up photograph of a modern door handle. The handle consists of a cylindrical stainless steel shaft with a black, textured grip section. The background is a dark, out-of-focus wall with a circular door lock mechanism visible behind the handle.

STAINLESS STEEL

FRITSCH

T-HALTER / MATTE AND ANTHRACITE FINISH

# CARRIERS



**FREEWAY**

Available for 5/8", 7/8" or 1 3/16" diameter rods.

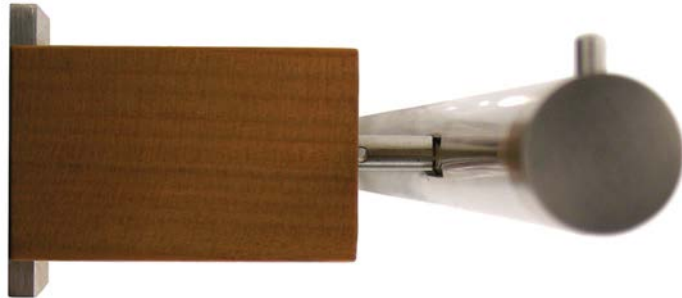

**PLOCC FREEWAY**

Available for 5/8", 7/8" or 1 3/16" diameter rods.

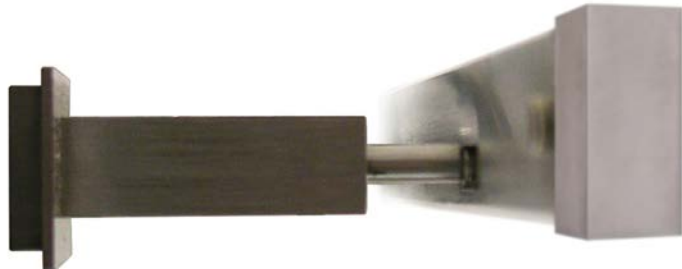

**FREEWAY 2510**

Available in 1" x 3/8".

All carriers available in standard wall distances of 2 3/4" or 3 7/8".

Stainless steel carriers available for single or double rods.

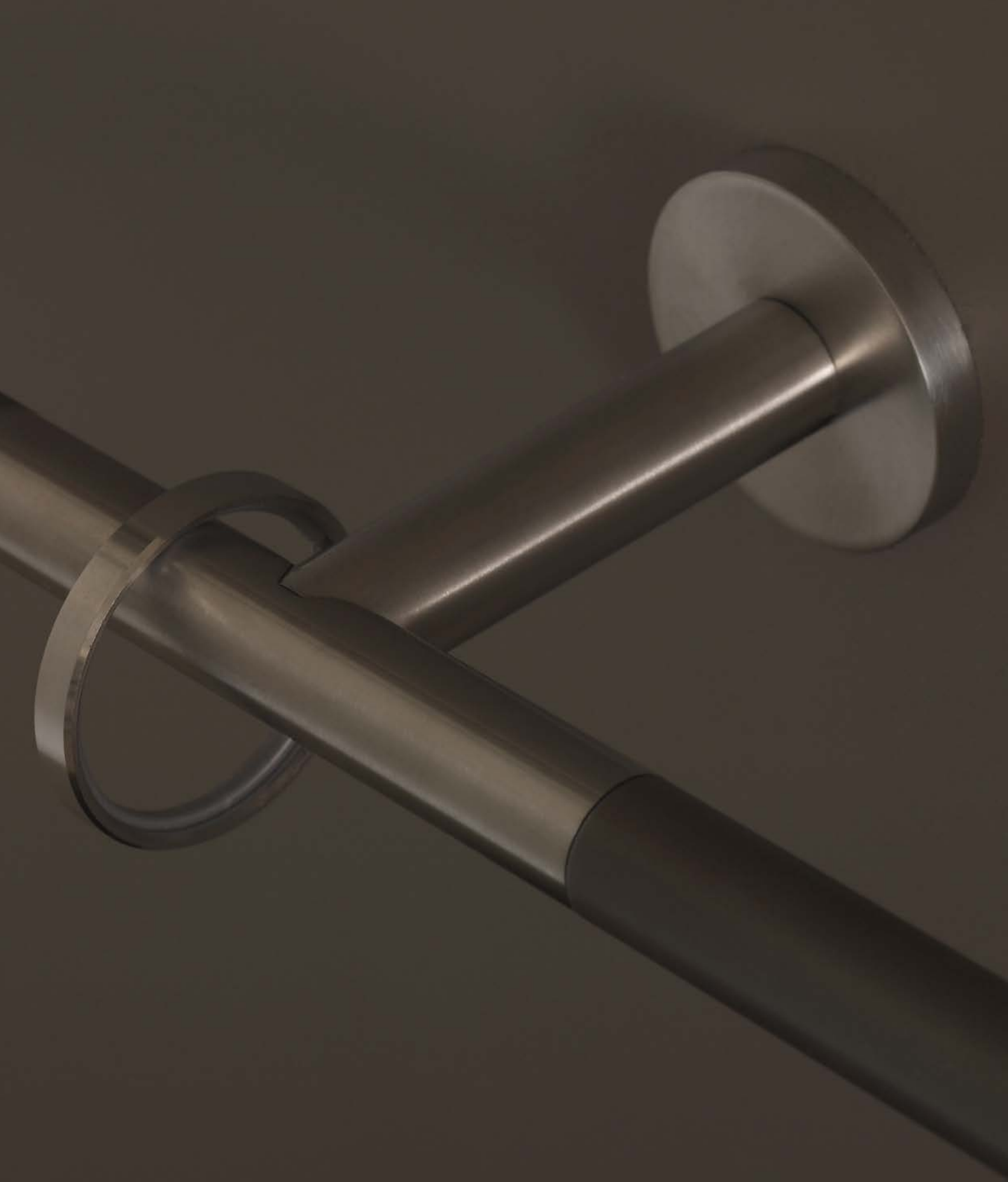

**FRITSCH**

T-HALTER / MATTE AND COFFEE BROWN FINISH



# CARRIERS



**CATO**  
Available for  $5/8$ " or  $7/8$ " diameter rods.



**RADIUSRETOURE**  
Available for  $5/8$ " or  $7/8$ " diameter rods.  
Used only on ends.



**T-HALTER**  
Available for  $5/8$ " diameter rods.  
Used only on ends.

All carriers available in standard wall distances of  $2\ 3/4$ " or  $3\ 7/8$ ".  
Stainless steel carriers available for single or double rods.

**FRITSCH**

# FINIALS



ZYLON



ZYLON with ring stop



CUP



SPUTNIK



KUGEL

Ball available in 1 1/4" or 1 1/2".

Available in 5/8", 7/8" or 1 3/16" diameter.

All finials available in brass or nickel with polished or matte finish.

**FRITSCH**



ITON



ITON with ring stop



TUBE



POINT



SAX



ZETA

Available in  $\frac{5}{8}$ " ,  $\frac{7}{8}$ " or  $1\frac{3}{16}$ " diameter.

**FRITSCH**



FRITSCH

FREEWAY 2510 / MATTE FINISH



# ACCESSORIES



ZYLON FOLDING ROD WITH RING STOP  
5/8" diameter

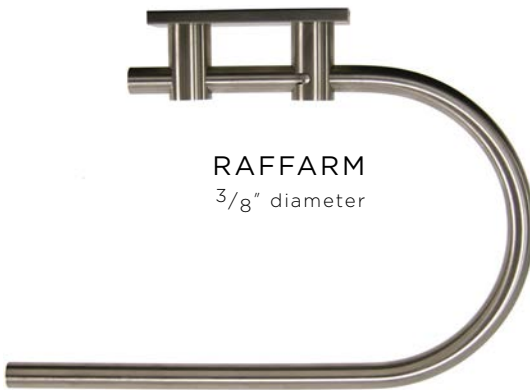

RAFFARM  
3/8" diameter



TIE-BACK  
5/8" diameter



HOOK  
5/8" diameter



STAINLESS  
STEEL RING  
Available in 1 3/8", 1 5/8" or 2".  
Also available with nylon inserts.



PASS-THROUGH RINGS  
Available for Freeway and Cato  
in 1 3/8" diameter or 1 5/8" diameter.  
Shown with nylon insert,  
also available without.



OVAL  
PASS-THROUGH RINGS  
Available in 1 1/8" x 3" or 2 1/8" x 4".



FREEWAY 2510  
ROLL-RING

Additional accessories available.

**FRITSCH**

# S-SERIES FORGED IRON

## FINIALS

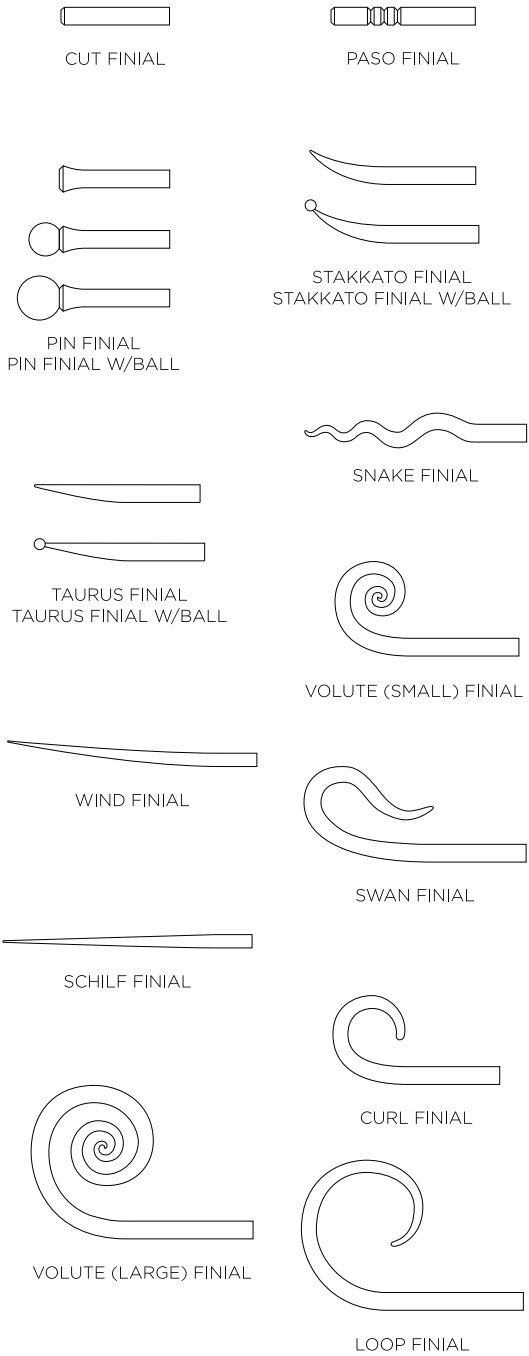

## CARRIERS

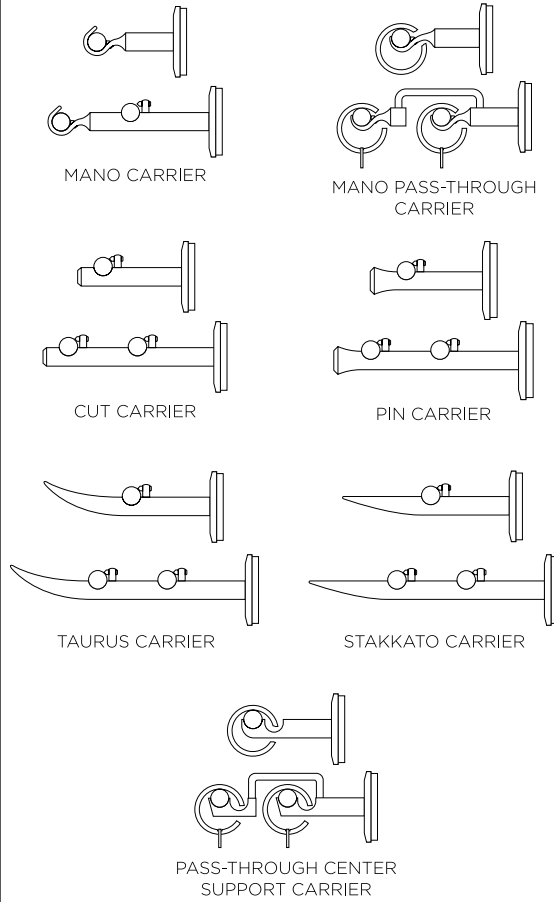

## BACK PLATES

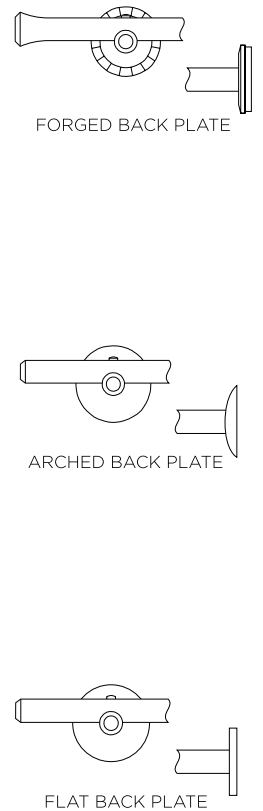

## FOLDING RODS

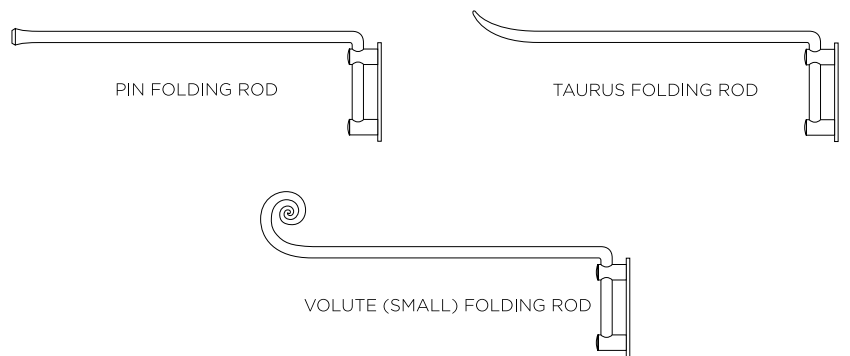

## ACCESSORIES

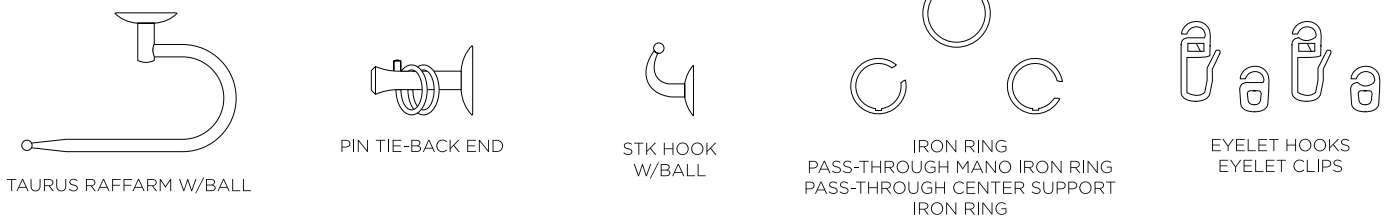

# TR-SERIES SMOOTH IRON

## FINIALS

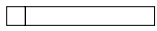

ZYLON FINIAL

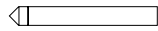

SPUTNIK FINIAL

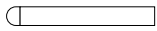

CUP FINIAL

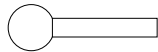

KUGEL FINIAL

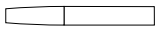

POINT FINIAL

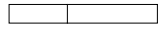

TUBE FINIAL

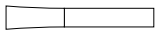

SAX FINIAL



ZETA FINIAL

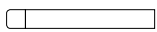

IRON FINIAL

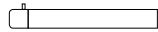

IRON FINIAL W/RING STOP

## CARRIERS

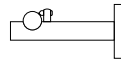

ZYLON CARRIER

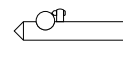

SPUTNIK CARRIER

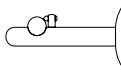

CUP CARRIER

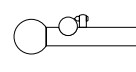

KUGEL CARRIER

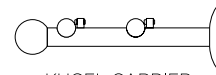
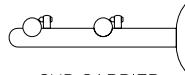

## BACK PLATES

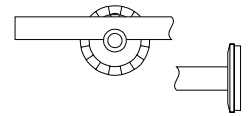

FORGED BACK PLATE

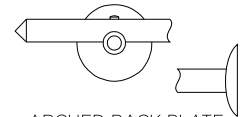

ARCHED BACK PLATE

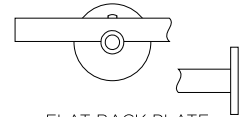

FLAT BACK PLATE

## FOLDING RODS



KUGEL FOLDING ROD



ZYLON FOLDING ROD  
W/RING STOP



SPUTNIK FOLDING ROD



ZYLON FOLDING ROD W/CUP

## ACCESSORIES

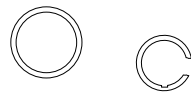

IRON RING  
PASS-THROUGH CENTER  
SUPPORT IRON RING



EYELET HOOKS  
EYELET CLIPS

# STAINLESS STEEL

## FINIALS

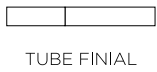
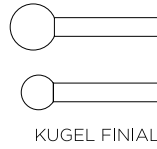
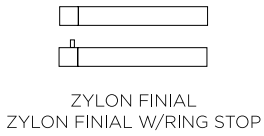

## CARRIERS

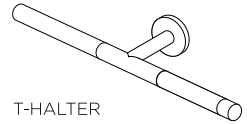
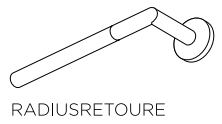
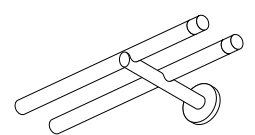
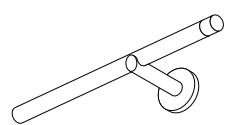
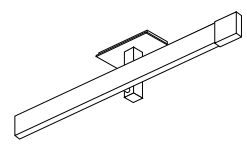
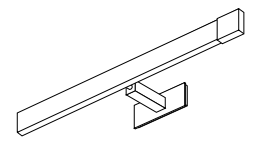
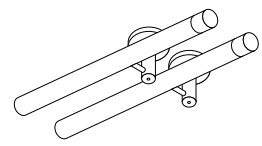
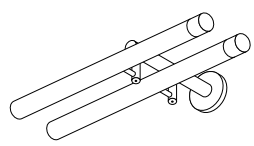
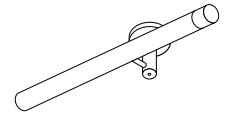
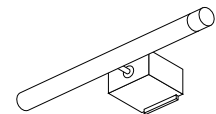
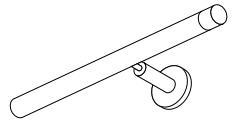

## ACCESSORIES

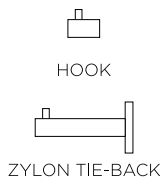
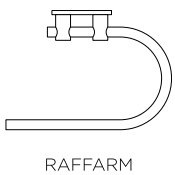

# ALUMINUM

## SQUARE TRACK SYSTEM

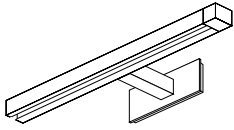

SQUARE WALL MOUNT

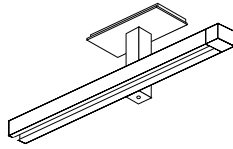

SQUARE CEILING CARRIER

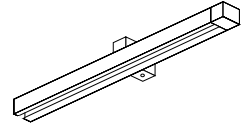

SQUARE FLUSH CEILING MOUNT

## T-HALTER TRACK SYSTEM

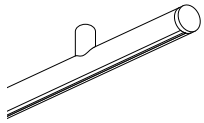

T-HALTER CEILING BRACKET

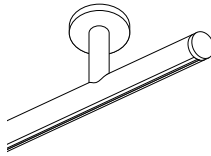

T-HALTER CEILING BRACKET W/PLATE

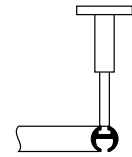

T-HALTER CEILING BRACKET FOR ANGLE INTERSECTION



T-HALTER FLUSH MOUNT CEILING BRACKET

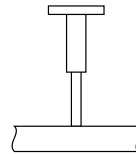

T-HALTER CEILING SUSPENSION BRACKET W/PLATE

## CATO TRACK SYSTEM

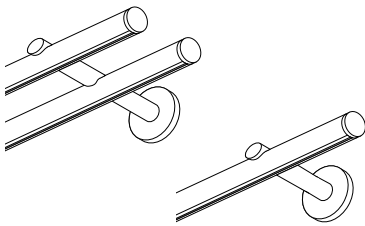

## FREEWAY TRACK SYSTEM

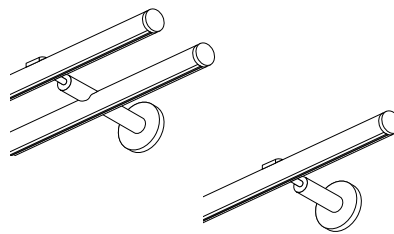

## RADIUS RETOURE TRACK SYSTEM

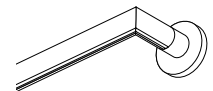

## ROLLERS & GLIDERS



ROLLER W/FOLDING HOOK

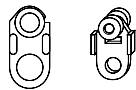

ROLLER W/EYE LOOP

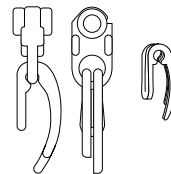

ROLLER W/DOUBLE HOOK

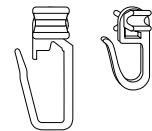

X-GLIDERS W/FOLDING HOOK

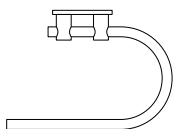

RAFFARM

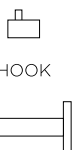

ZYLON TIE-BACK

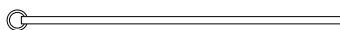

BATON

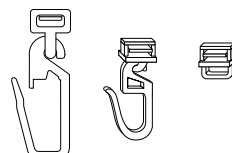

CLICK GLIDERS W/FOLDING HOOK

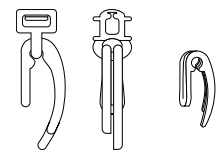

CLICK GLIDERS W/DOUBLE HOOK



**FRITSCH**

RADIUSRETOURE / MATTE AND COFFEE BROWN FINISH





FRITSCH

FREEWAY PANEL GLIDE SYSTEM / MATTE FINISH



FOR MORE INFORMATION CONTACT YOUR REPRESENTATIVE SHOWROOM.