

STAINLESS STEEL BRACKETS

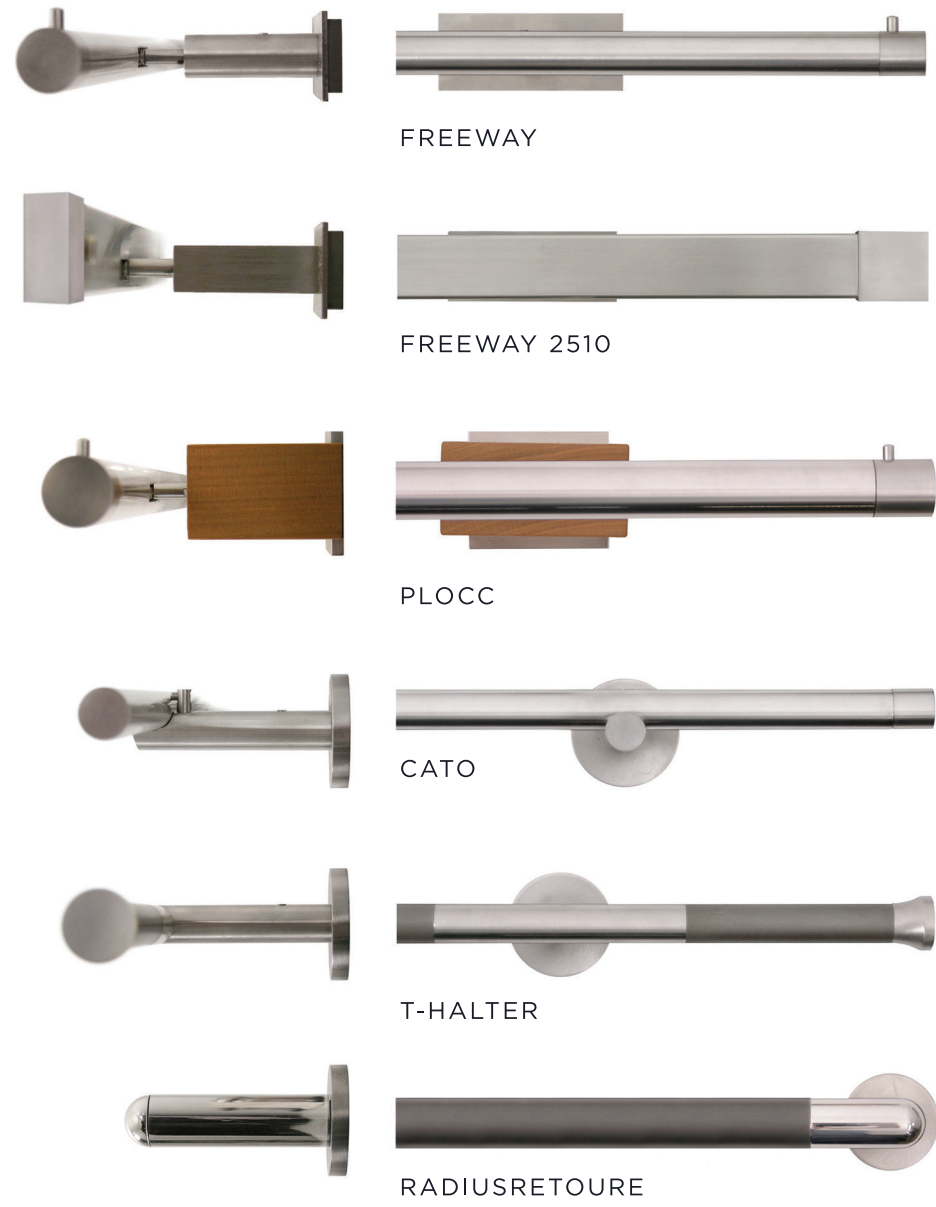

SQUARE ALUMINUM TRACK SYSTEM

Available in brushed or polished finish.

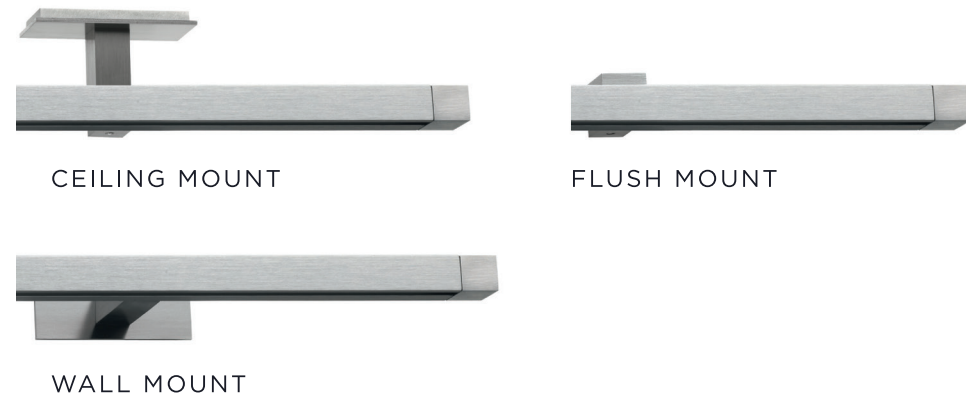

ROUND ALUMINUM TRACK SYSTEM

Available in brushed or polished finish.

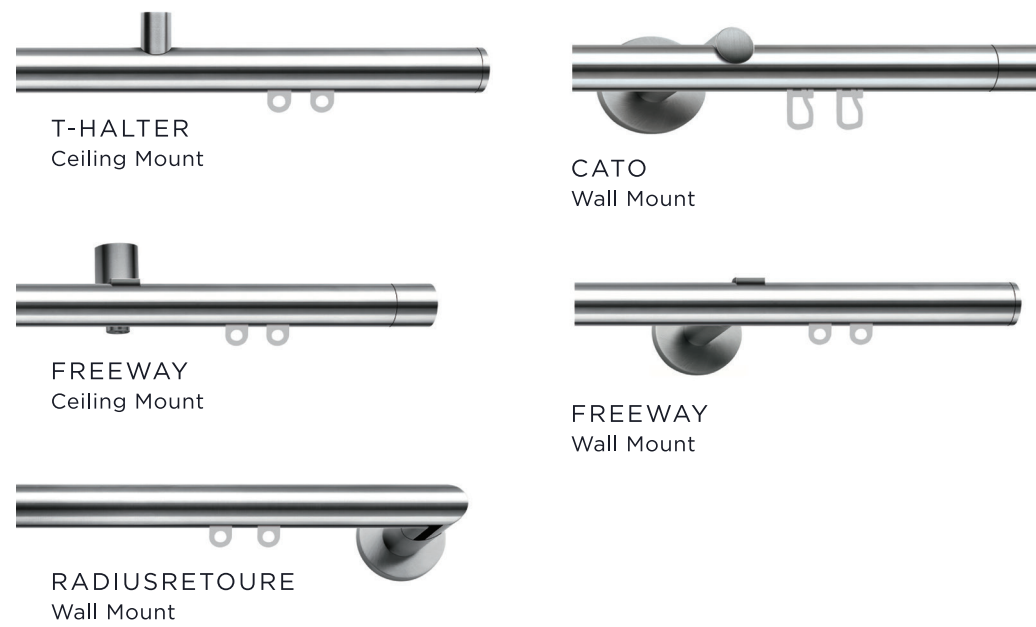

STAINLESS STEEL FINIALS



All stainless steel finials are available in stainless steel or brass with polished or brushed finish.

STAINLESS STEEL FINISHES

Available in custom colors. Brushed finish sold standard.

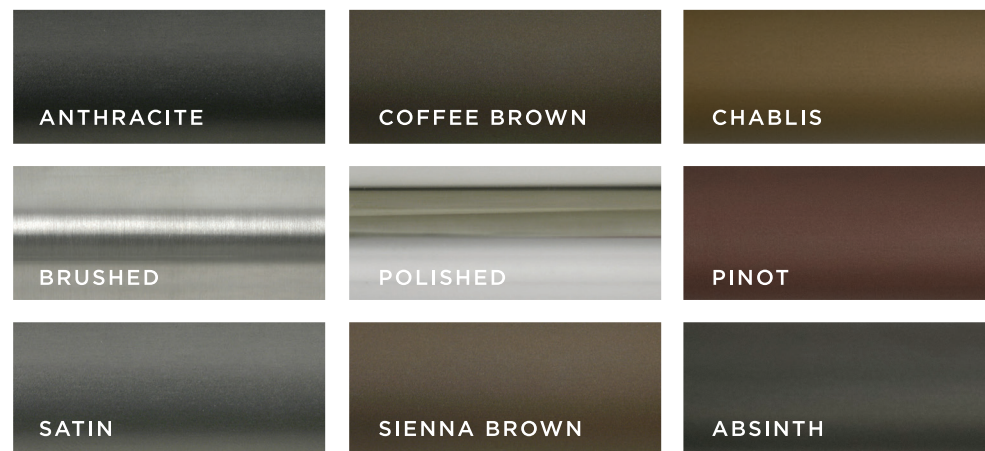

FOLDING RODS + ACCESSORIES

Additional accessories available.

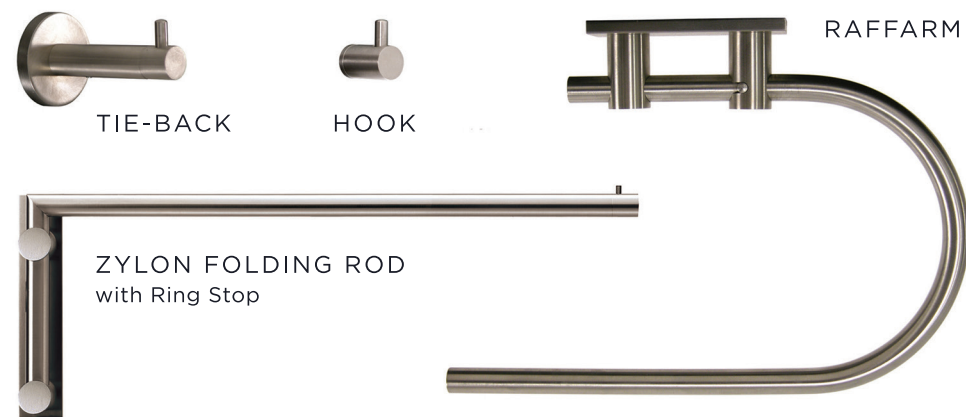

STAINLESS STEEL RINGS

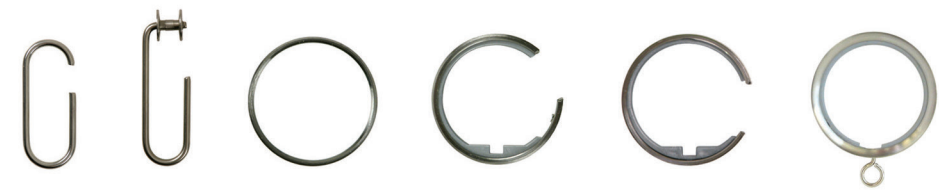

Left to right: Oval Pass-Through Ring, Freeway 2510 Roll-Ring, Stainless Steel Ring, Freeway Pass-Through Ring, Cato Pass-Through Ring, Stainless Steel Ring with Nylon Insert and Brass Eyelet.

F R I T S C H



STAINLESS STEEL ALUMINUM TRACK SYSTEM  
FORGED IRON SMOOTH IRON

FORGED IRON FINIALS



FORGED IRON BRACKETS



IRON FOLDING RODS + ACCESSORIES

Additional accessories available.

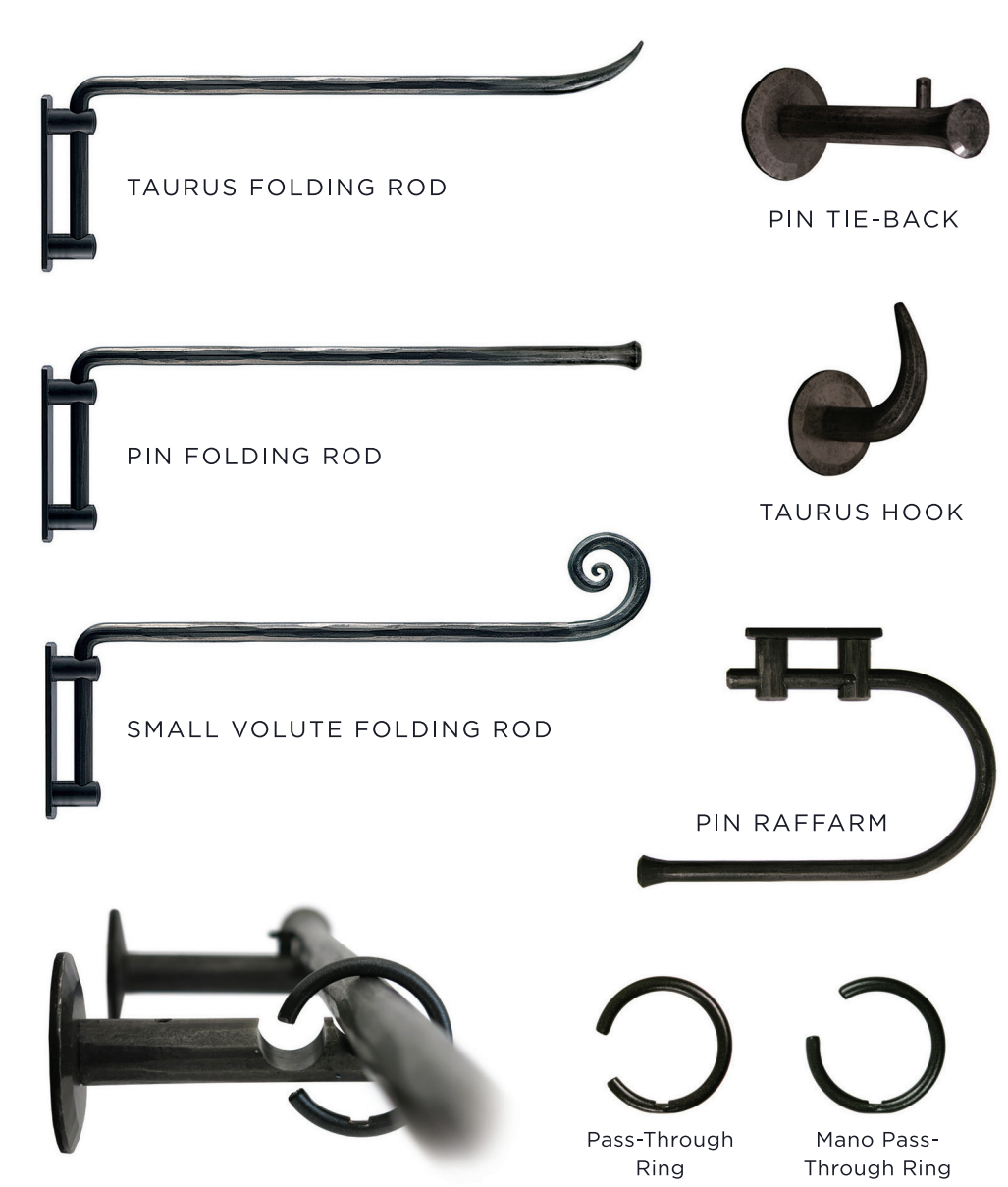

SMOOTH IRON BRACKETS + FINIALS

Smooth iron brackets and finials are available in iron, brass or nickel.



FORGED IRON FINISHES

Available in custom colors. Iron finish sold standard.



ABOUT FRITSCH

The Fritsch collection of transitional iron and sleek artisan steel drapery hardware is handcrafted in Germany. Fritsch incorporates innovation with an unrivaled level of craftsmanship and offers a vast range of beautiful finishes and thoughtful details that are fully customizable allowing for a variety of versatile applications. Please call 626.298.3500 or email [scott@fritschdraperyhardware.com](mailto:scott@fritschdraperyhardware.com) if you have questions.

[www.fritschdraperyhardware.com](http://www.fritschdraperyhardware.com)

\*Brass or nickel available in polished or matte finish.